

# CONCEALED HINGES

## CONCEALED HINGE

995

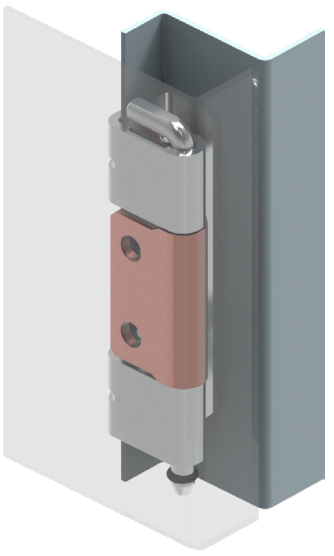
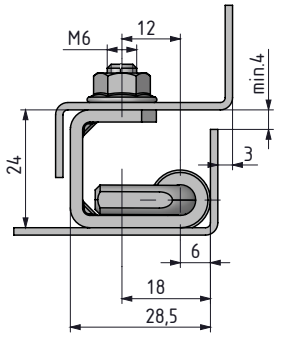
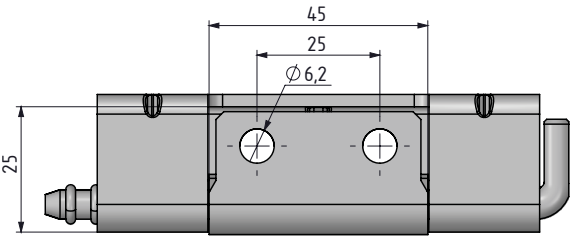
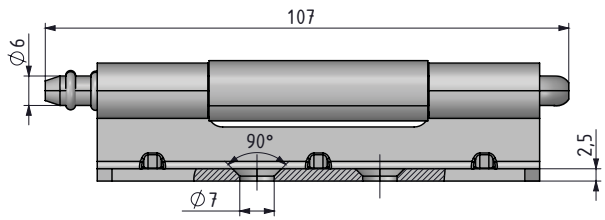
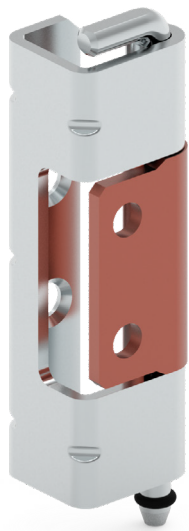

- Stainless Steel version: page: 491
- Side part can be mounted with M5 screws
- Centre part copper plated for easy welding
- Suitable for heavy-duty applications
- Suitable for 25 mm bend door cabinets

**MATERIAL**  
Steel

**FINISH**  
BODY: Zinc plated  
WELDING PART: Copper plated (MP1)

**Note:** Bolts are not supplied



**Note:** Nuts are not supplied

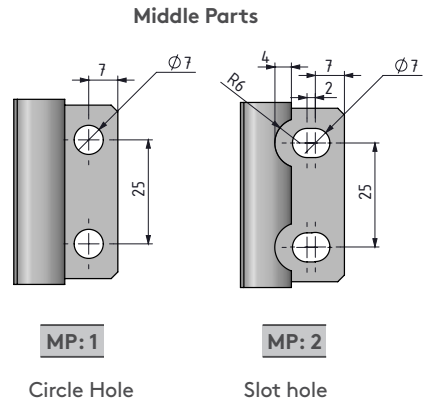
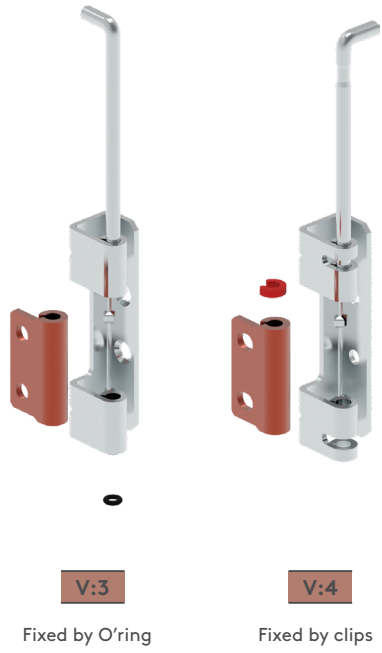

Group Code	Material	Finish	Version	Middle Part	Option
995	6	3	V	MP	OP

OPTION	OP
Hole	0
Stud	1